

INSTALLATION INSTRUCTION

Spirerne

NOORD

RECOMMENDATIONS FOR INSTALLATION

The guarantee demands that NOORD's recommendations for installation and maintenance are met.

When installing the equipments we highly recommend to follow the guidelines according to EN 16630 ("Permanently installed outdoor fitness equipment — Safety requirements and test method"), as showed below.

FOUNDATIONS

Foundations shall be designed such that they do not present a hazard (e.g. tripping, impact).

In the case of loose fill material (e.g. sand), foundations shall be installed or laid in accordance with one of the following:

- a. foundations of the equipment to which the pedestals, footings and fixings are attached shall be at least 400 mm below the ground surface or the installed depth of surfacing; or

Note: This does not include the socket of post shoes or similar which a continuation of the attached post.

- b. the top of the foundations shall be at least 200 mm below the ground surface, as shown in the example below; or
- c. foundations shall be covered by pieces of equipment or equipment parts; or
- d. foundations shall be formed by above ground support shoes.

Any parts protruding from the foundations (e.g. ends of screws) shall be at least 400 mm below the ground surface, unless they are effectively covered.

Example of foundations

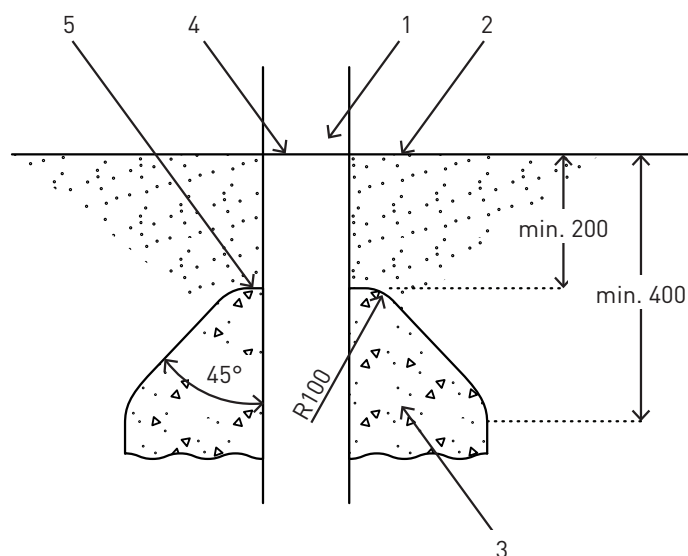

Dimensions in millimetre

KEY

1. Post
2. Ground surface
3. Foundation
4. Basic level mark
5. Top of foundation

SPIRER 2300

Product no.: no-010

Measurements: L90 x W60 x H230 cm



MOUNTING ACCESSORIES

 2 pcs. mandrels for anchor points

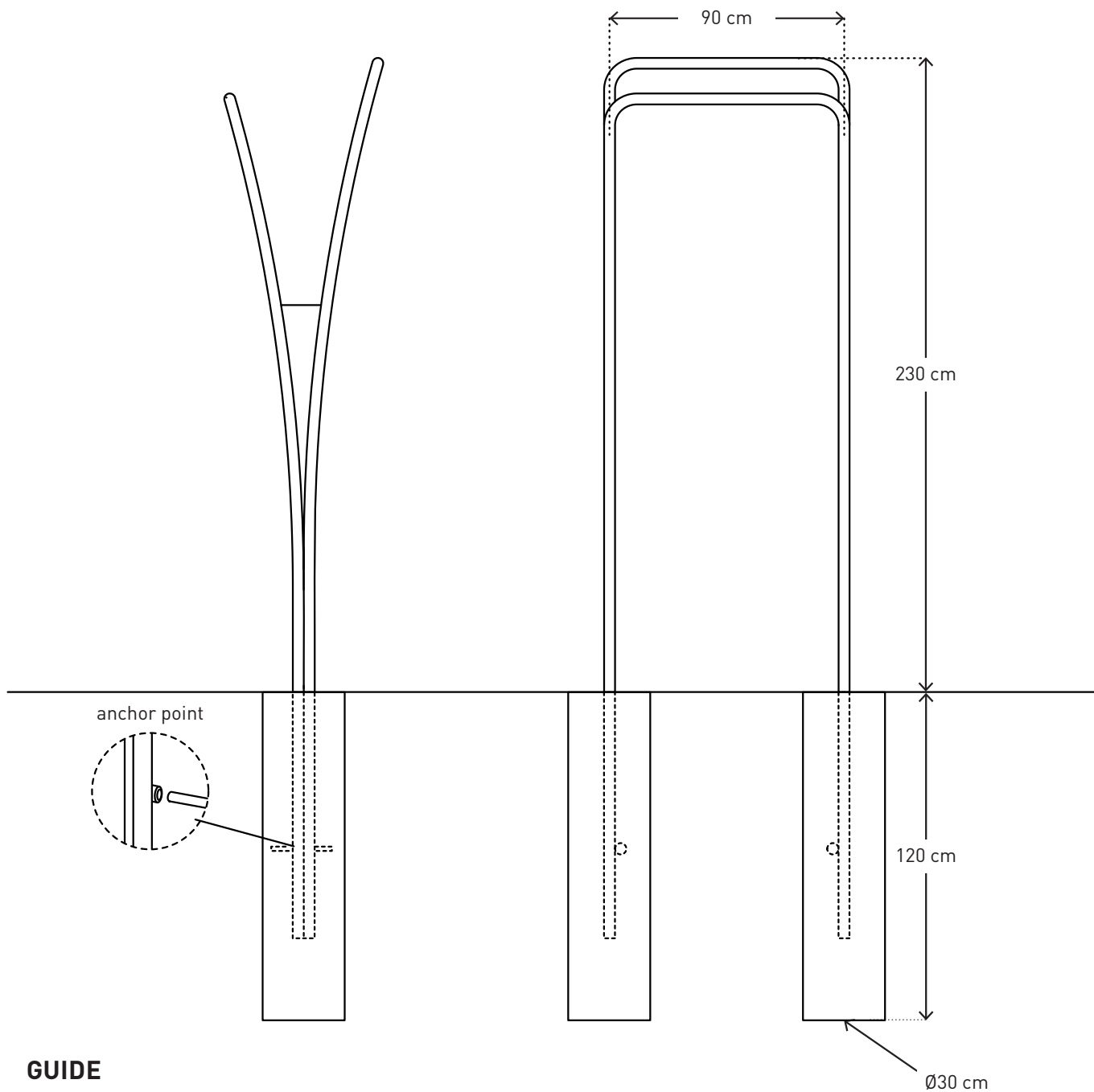

GUIDE

1. Place the mandrels
2. Drill holes in the dimensions as listed above
3. Fill the holes with concrete
4. Place the equipment in the holes, leveled and with the right dimensions

DISTANCES

Training area 
Area of movement 

